

3/8" NPT
INLET/OUTLET PORTS

**SERIES 3
ROTARY VANE PUMP
BOLT-ON STYLE
"L" MOUNTING
3/8" NPT PORTS**

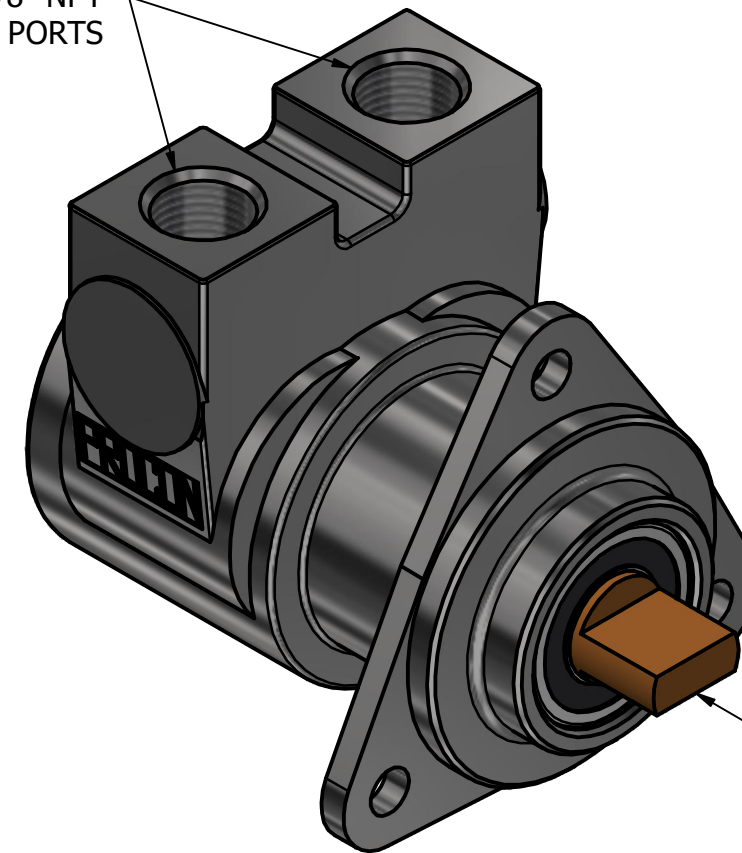

3018-1 BRONZE COUPLING

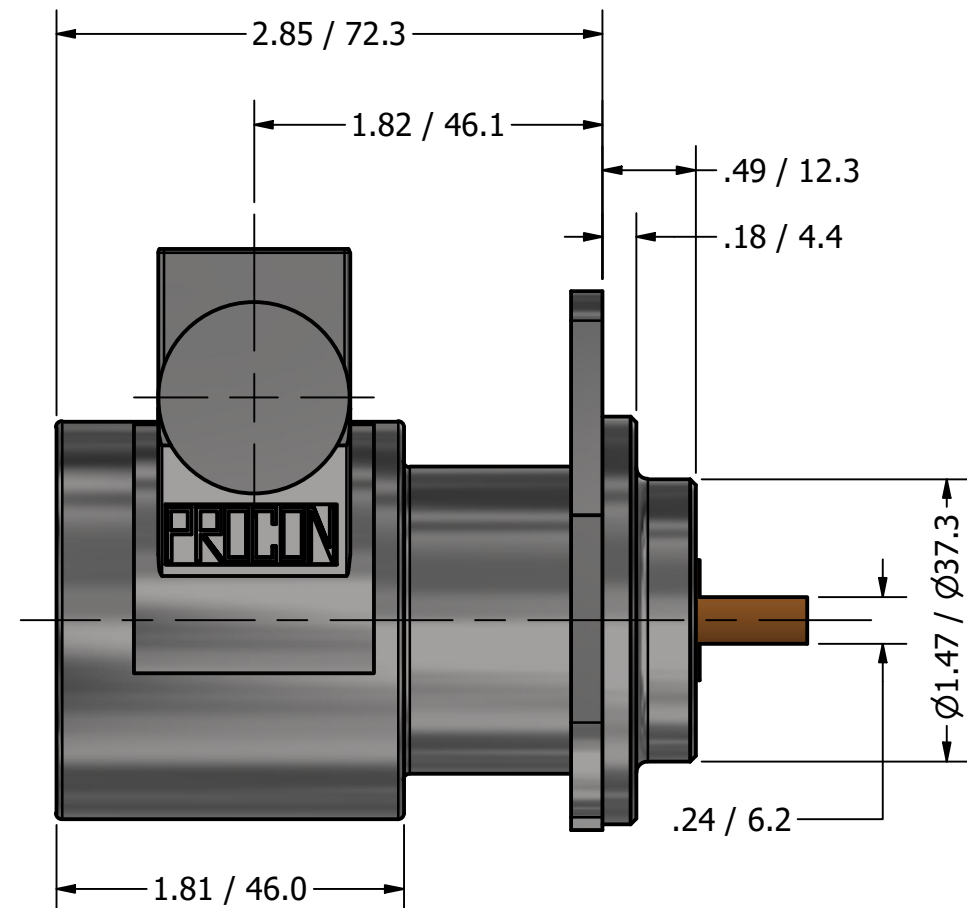

$\phi 2.75 / \phi 69.9$ B.C.

$\phi .28 / \phi 7.1$
3 EQUALLY
SPACED HOLES

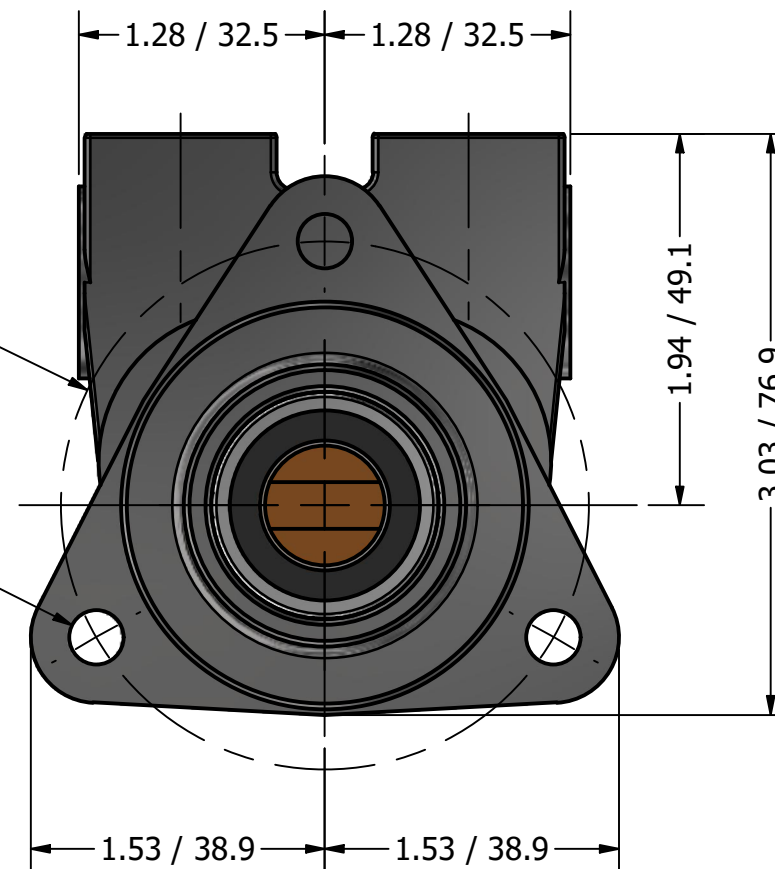

PROCON[®]
custom | fluid | solutions[®]