

M4 X 0.7 X .236±.01 / 5.99±0.3 DEEP
4 PLCS

MICRO GEAR PUMP 40 WATT MOTOR G1/8 (BSPP) PORTS

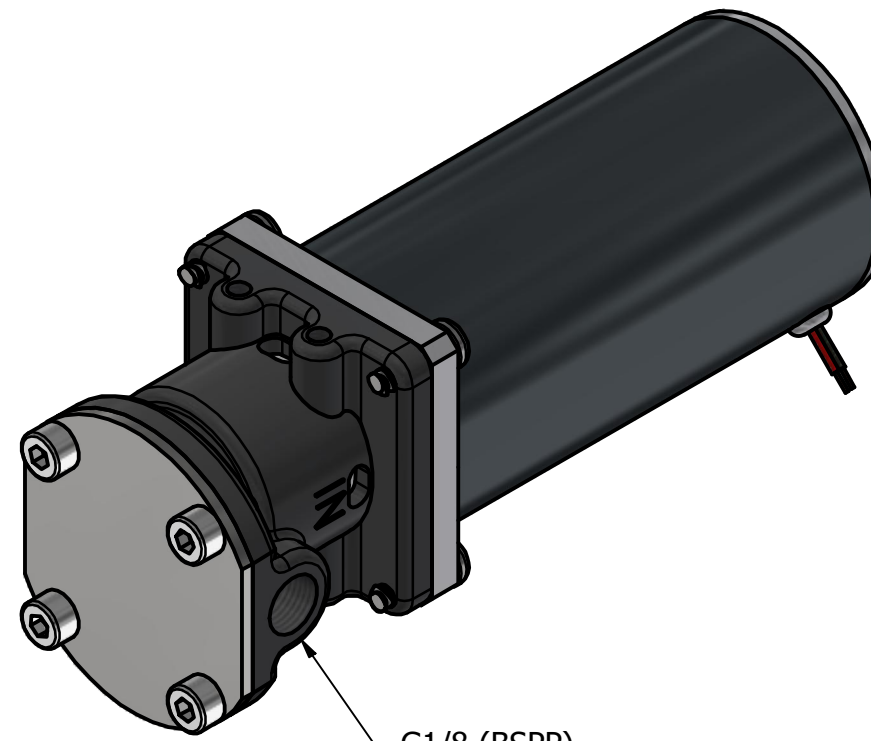

G1/8 (BSPP)
INLET/OUTLET PORTS

