

**MICRO GEAR PUMP
40 WATT MOTOR
G1/8 (BSPP) PORTS**

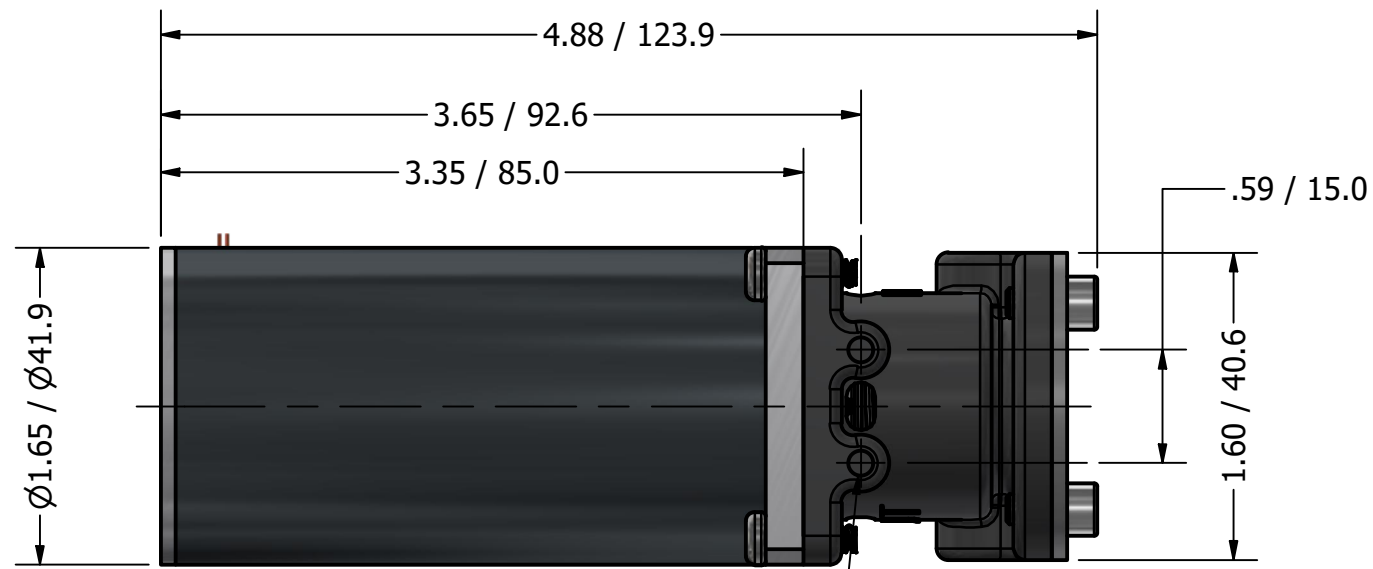

M4 X 0.7 X .236±.01 / 5.99±0.3 DEEP
4 PLCS

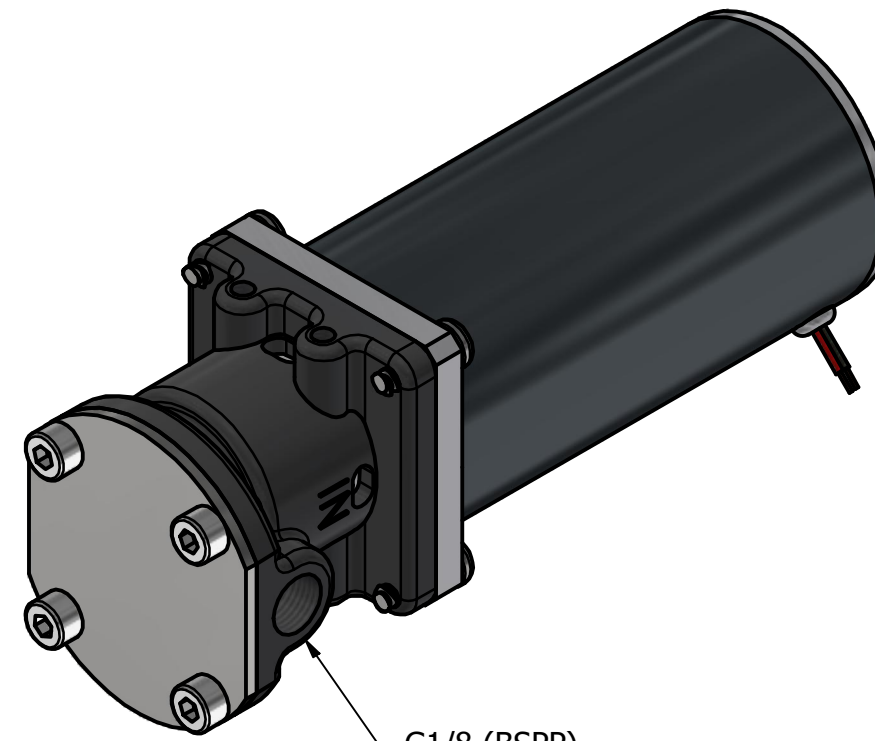

G1/8 (BSPP)
INLET/OUTLET PORTS

